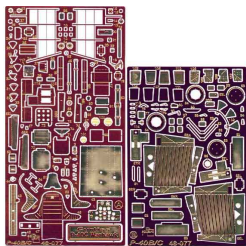

Part S48-077 1/48 P-40 B/C Warhawk (Academy / Hobby Craft)**Cena :****72,00 PLN**Producent : **Part (Poland)**Dostępność : **Jest**Stan magazynowy : **bardzo wysoki**Średnia ocena : **brak recenzji****Part S48077 P-40 B/C Warhawk (1/48)***Najwyższej jakości elementy fototrawione do modeli firmy **ACADEMY / HOBBYCRAFT***

Zestaw zawiera:

- 2 arkusze blaszki miedzianej
- arkusik przezroczystej folii
- szczegółową instrukcję składania

Producent: **PART** (Polska)

UWAGA

Elementy fototrawione należy przyklejać klejami cyanoakrylowymi. Pracę wykonywać w miejscu dobrze wentylowanym. Nie wdychać oparów kleju. Po skończonej pracy umyć ręce.

CAUTION

Photo-etched parts can only be glued with cyanoacrylate glue. Work in a well ventilated area. Do not inhale vapors since these can be harmful. Wash your hands after using.

PO DRUGIEJ STRONIE
OPPOSITE SIDE



ODCIĄĆ
REMOVE



ZAGIĄĆ
BEND



TŁOCZYĆ
PRESS

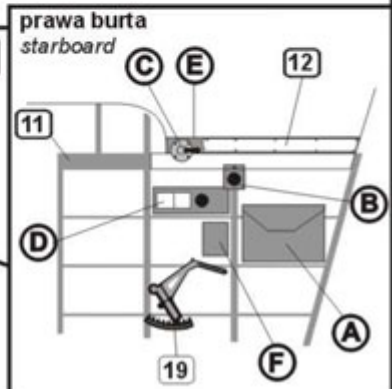
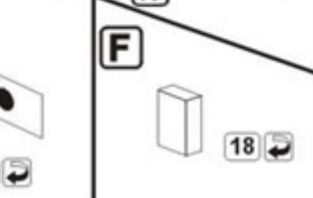
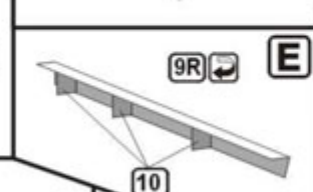
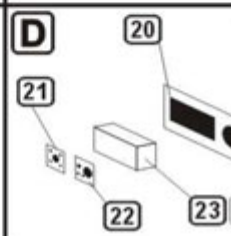
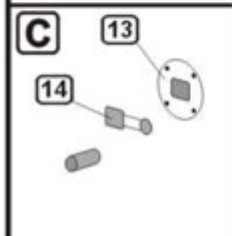
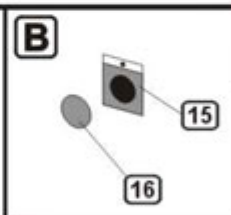
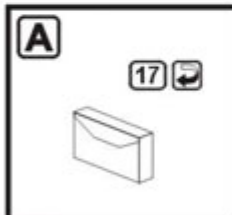
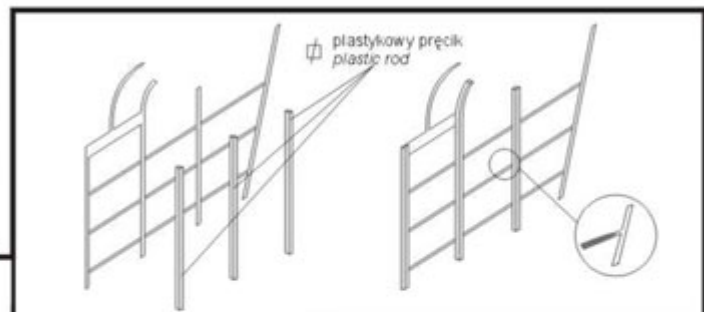
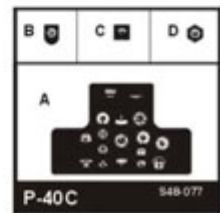
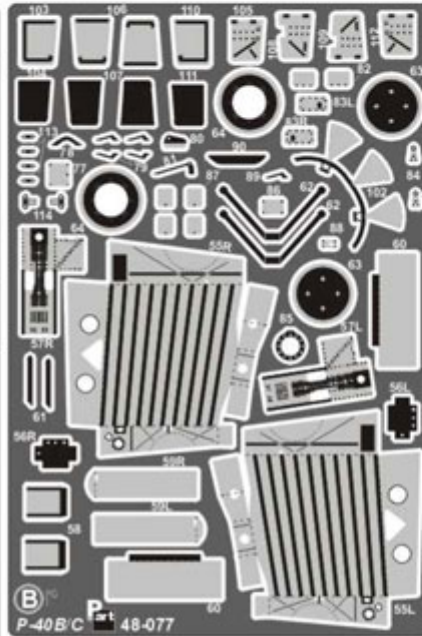
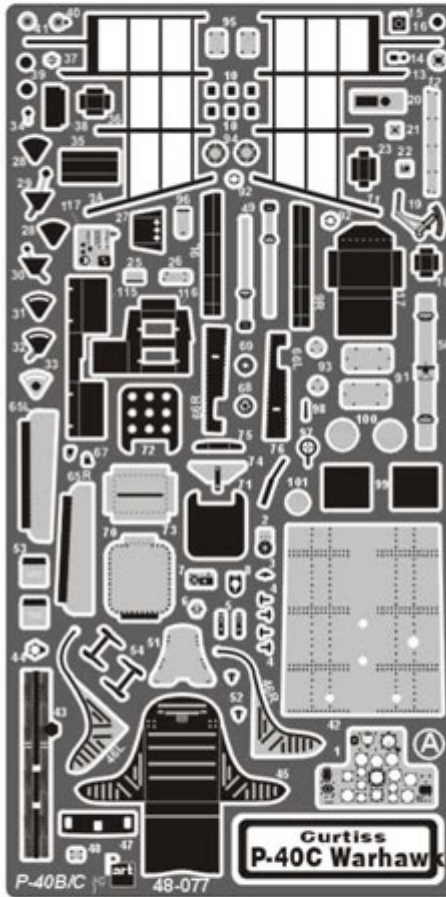

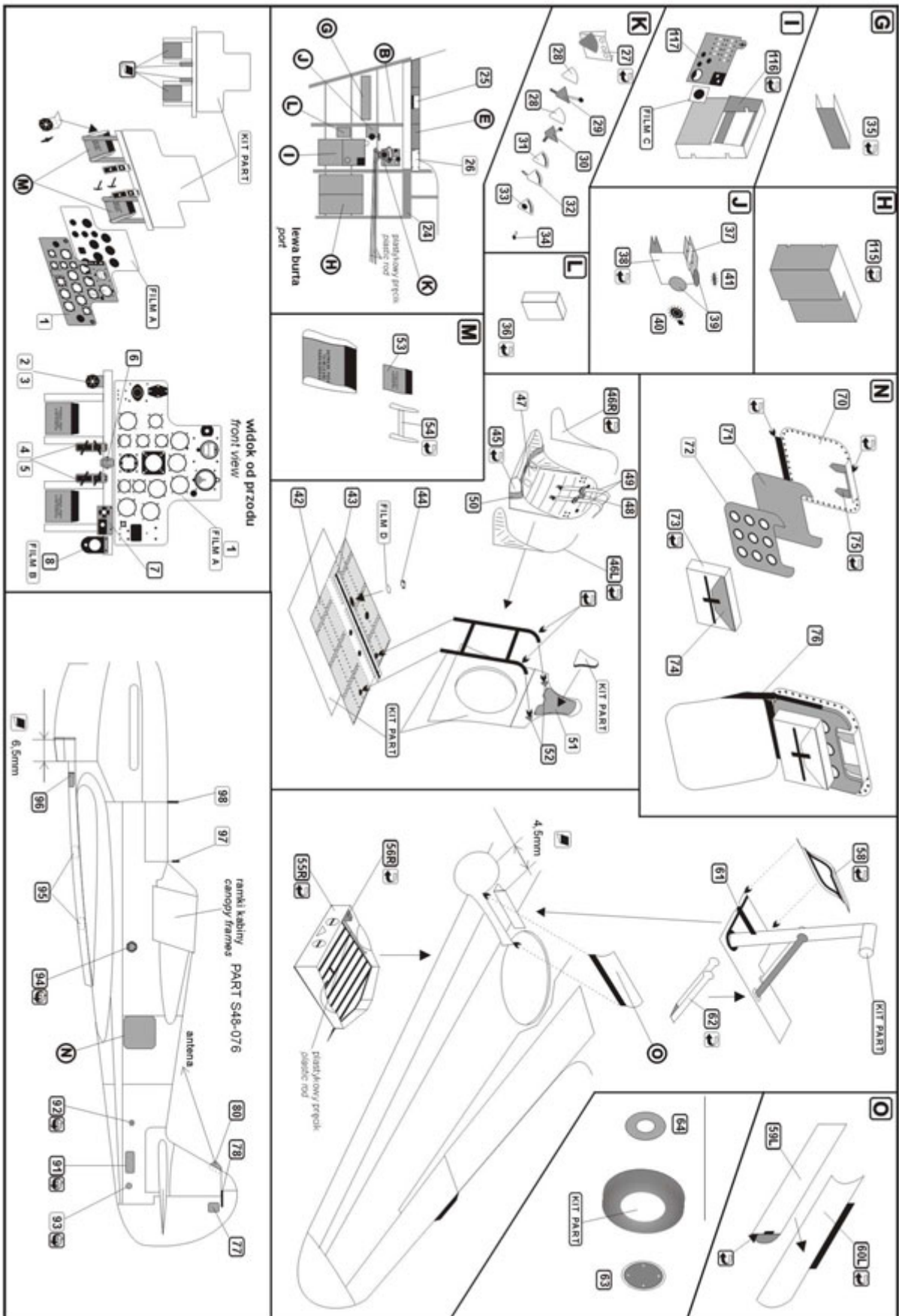

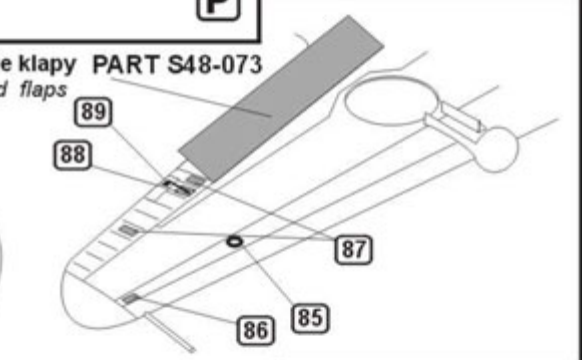
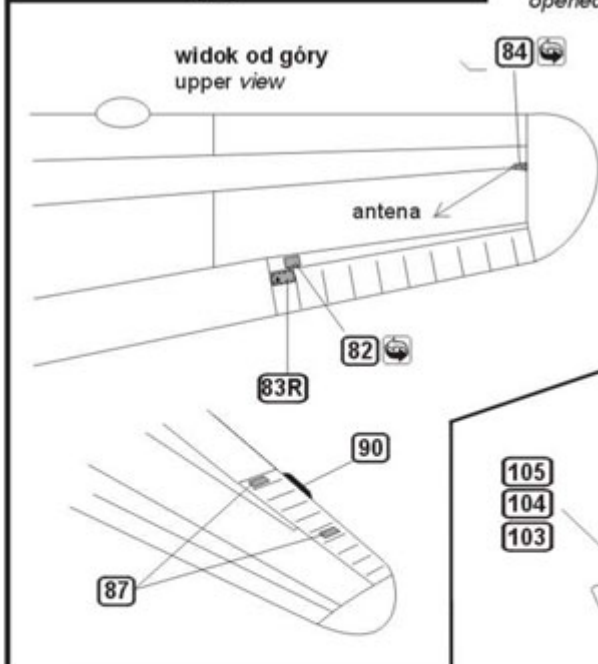
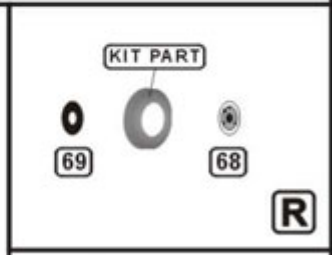
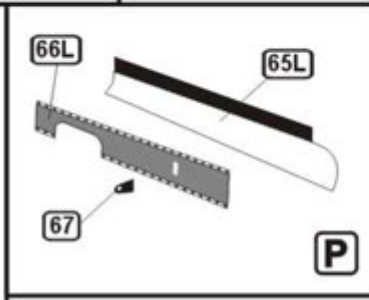
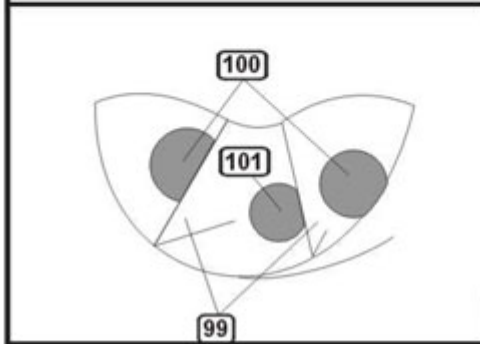
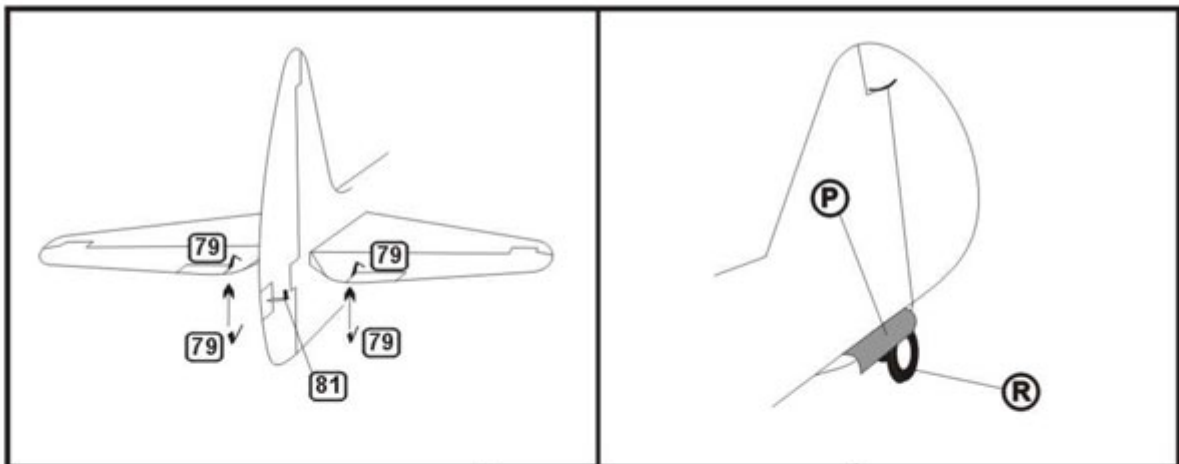

Bibliografia:
 - Walk Around Nr 8
 - In Detail and Scale Nr 61
 - Monografie Lotnicze Nr 64
 - MBI

