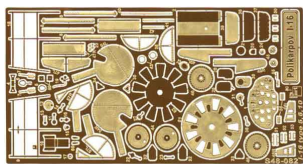

Part S48-082 1/48 Polikarpov I-16 type 5, 6, 10 (Academy / Hobby Craft)**Cena :****49,00 PLN**Producent : **Part (Poland)**Dostępność : **Jest**Stan magazynowy : **bardzo wysoki**Średnia ocena : **brak recenzji****Part S48082 Polikarpov I-16 type 5, 6, 10 (1/48)***Najwyższej jakości elementy fototrawione do modeli firmy **ACADEMY***

Zestaw zawiera:

- 1 arkusz blaszki miedzianej
- arkusik przezroczystej folii
- szczegółową instrukcję składania

Producent: **PART** (Polska)

DETAIL SET FOR PLASTIC KIT
"Part" (0-42) 640-40-76
www.part.pl

1:48 scale detail set for ACADEMY HOBBYCRAFT

UWAGA

Elementy fototrawione należy przylepiać klejami cyjanoakrylowymi. Pracę wykonywać w miejscu dobrze wentylowanym. Nie wdychać oparów kleju. Po skończonej pracy umyć ręce.

CAUTION

Photo-etched parts can only be glued with cyanoacrylate glue. Work in a well ventilated area. Do not inhale vapors since these can be harmful. Wash your hands after using.

PO DRUGIEJ STRONIE
OPPOSITE SIDE



ODCIĄĆ
REMOVE



ZAGIAĆ
BEND

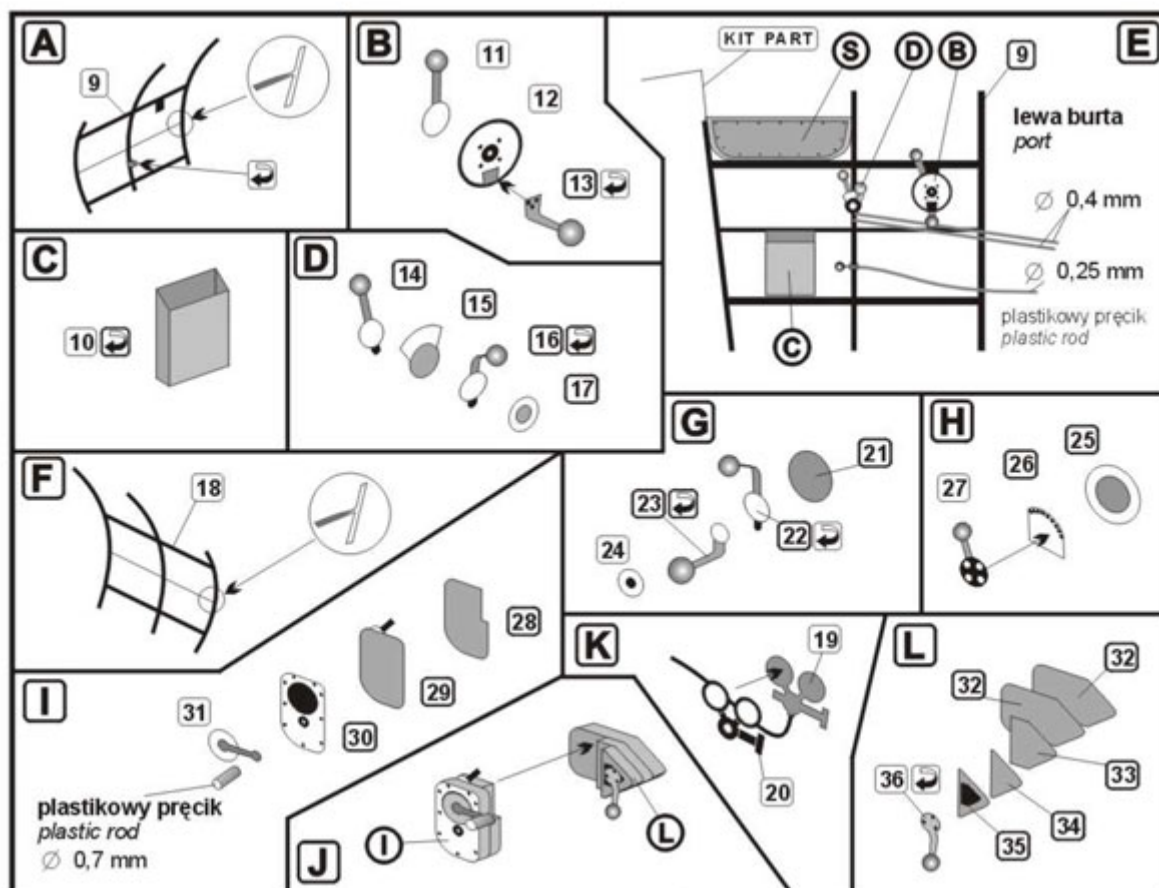
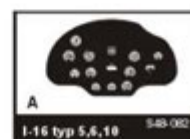
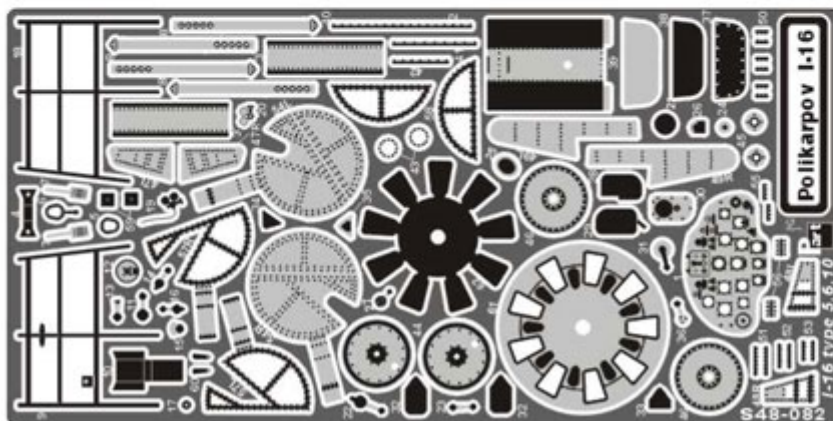

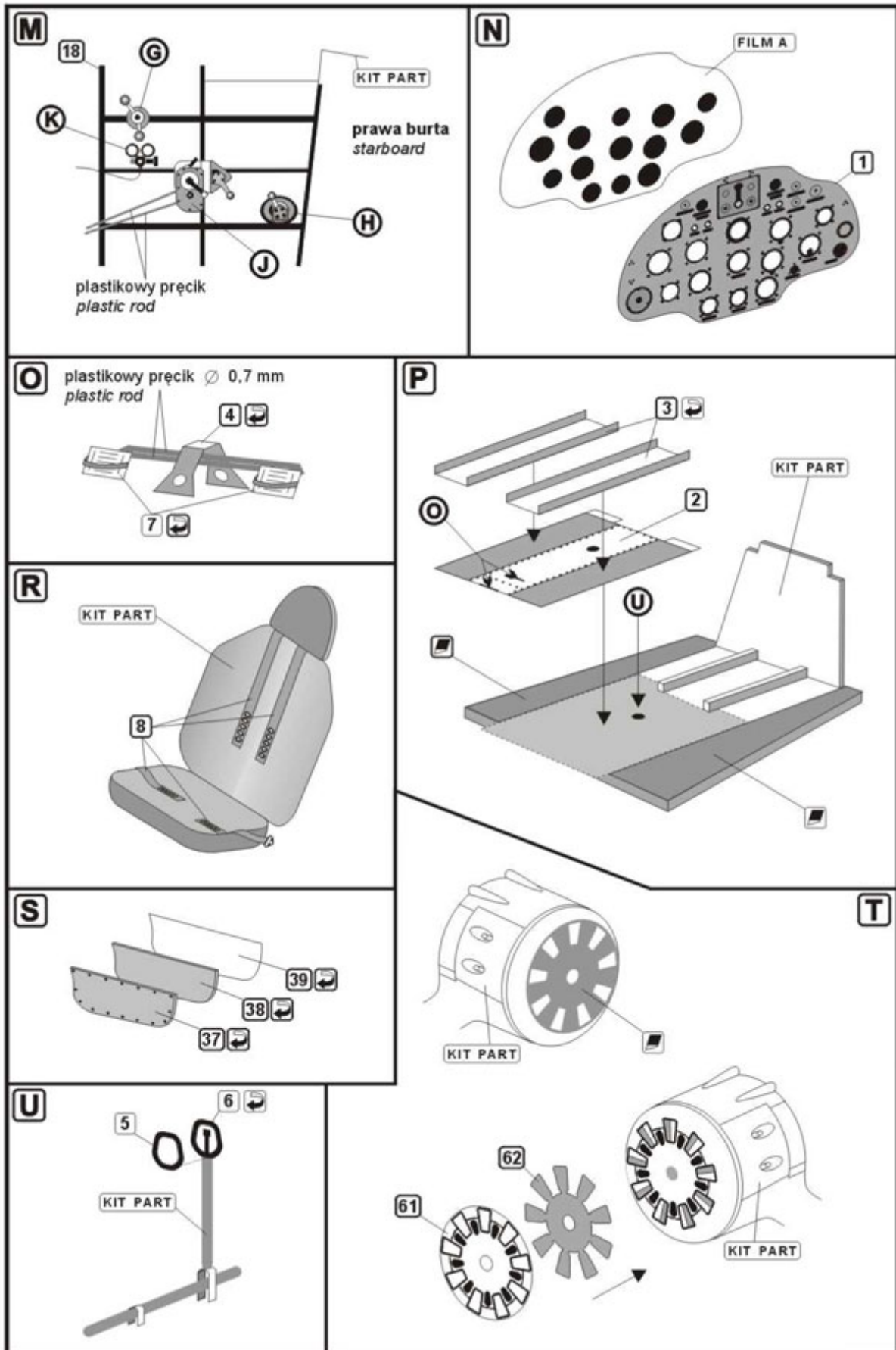

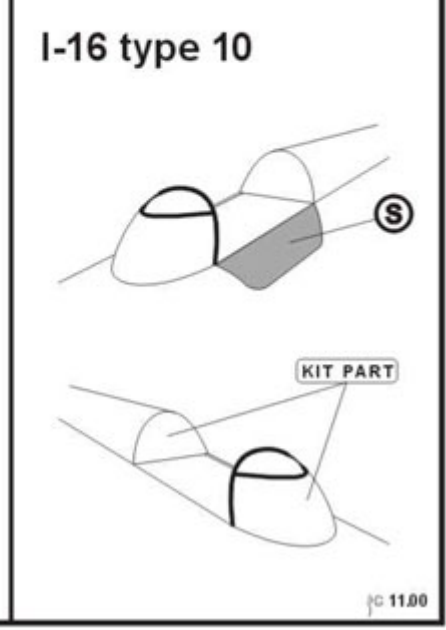
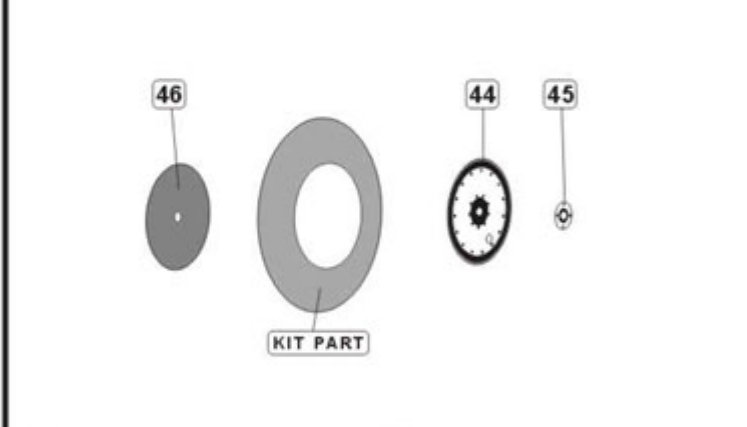
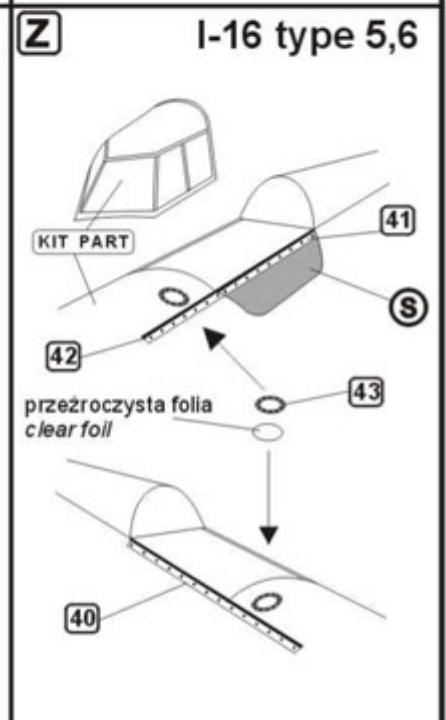
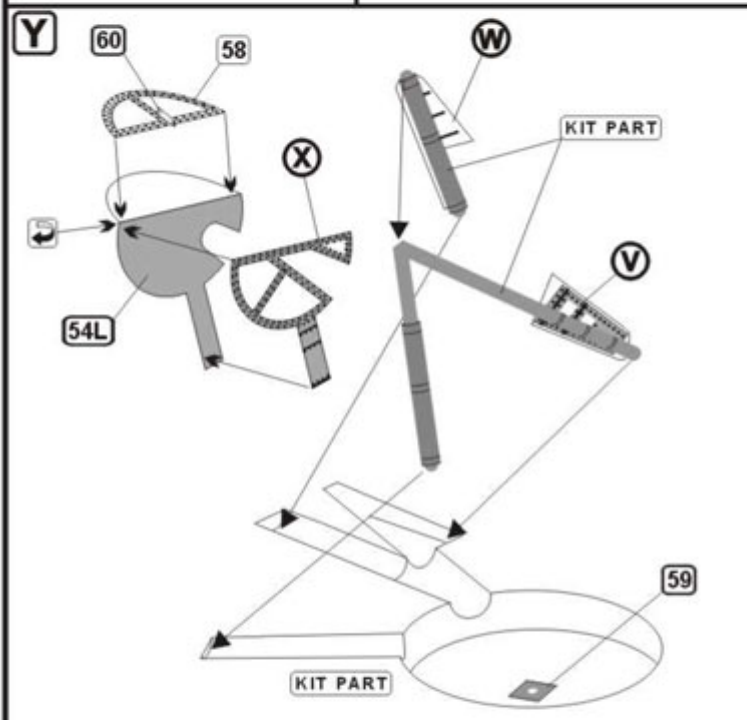
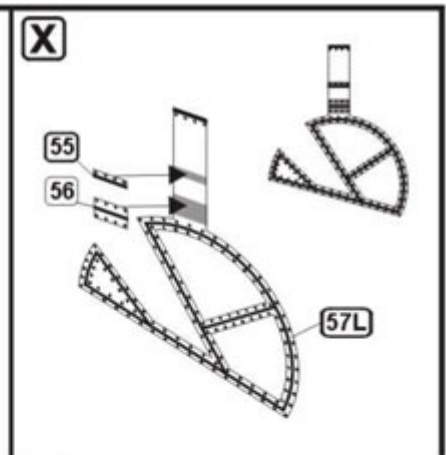
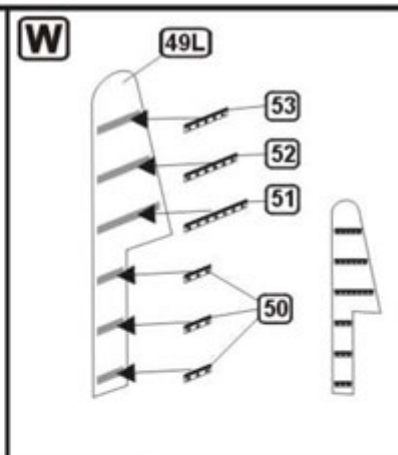
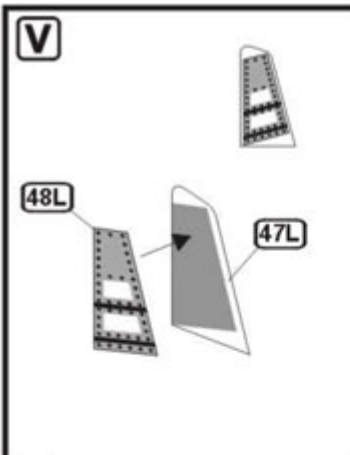

Bibliografia:
 -Modelist Konstruktor 9/82
 -L+K 18,19,20,21/88
 -Lotnictwo Wojskowe 3/2000
 -TBiU Nr 48

